



Breitenstrasse 10 4852 Rothrist  
Tel. +41 (0)62 797 03 03 Fax +41 (0)62 797 03 04

OBJEKT:

ORT:

PROJEKT NR:

ANLAGE: *STEUERUNG ZU WARMEPUMPE AWST36 1LT8.1  
- LEGIONELLENHEIZUNG 6kW*

ERSTELL-DATUM: 06.05.2020 DUN

REVISIONS-DATUM:



STRIEGA-THERM AG  
STEUERUNG ZU WARMEPUMPE  
LEGIONELLENHEIZUNG AWST36 1LT6.1

DECKBLATT

Projekt: AWST36_1LT8.1	Zeichnungsnummer:	Rev.:	erstellt von:
Datum: 06.05.2020	Anlage:	Ort:	Blatt: 1

1 2 3 4 5 6 7 8

A

B

C

D

E

F

A

B

C

D

E

F

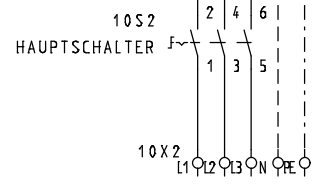
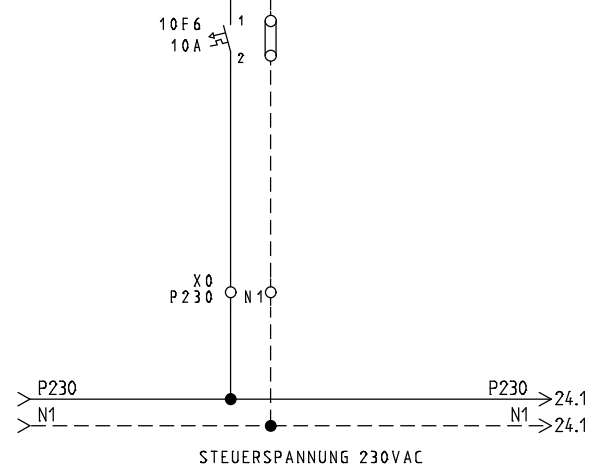
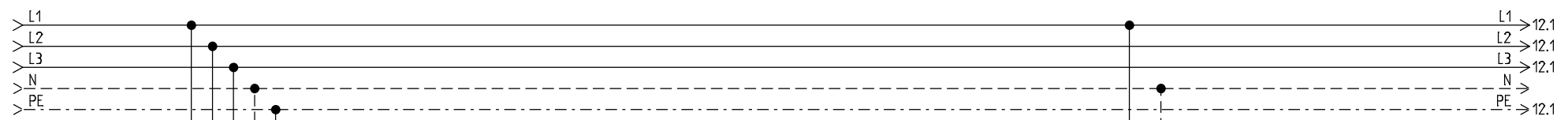

EINSPEISUNG  
3X400/230VAC/16kW/50Hz

EMPFOHLENE ABSICHERUNG **40AT**  
WÄRMEPUMPE MIT HEIZUNG

MINIMALE ABSICHERUNG 25AT  
WÄRMEPUMPE OHNE HEIZUNG



STRIEGA-THERM AG  
STEUERUNG ZU WÄRMEPUMPE  
LEGIONELLENHEIZUNG AWST36 1LT6.1

EINSPEISUNG

Projekt:  
AWST36\_1LT8.1

Datum:  
06.05.2020

Zeichnungsnummer:

Anlage:

Rev.:

Ort:

erstellt von:

Blatt:  
10

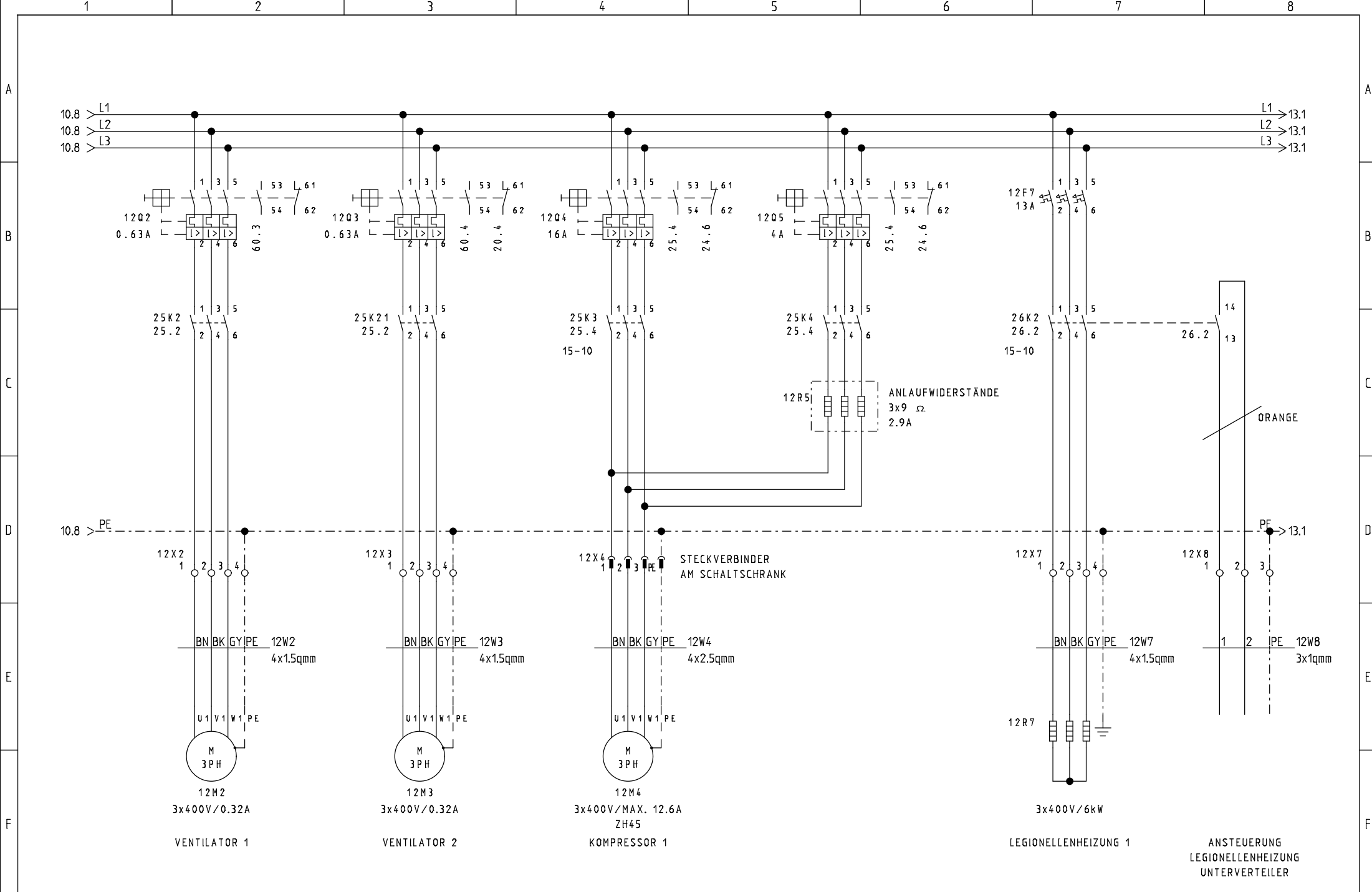

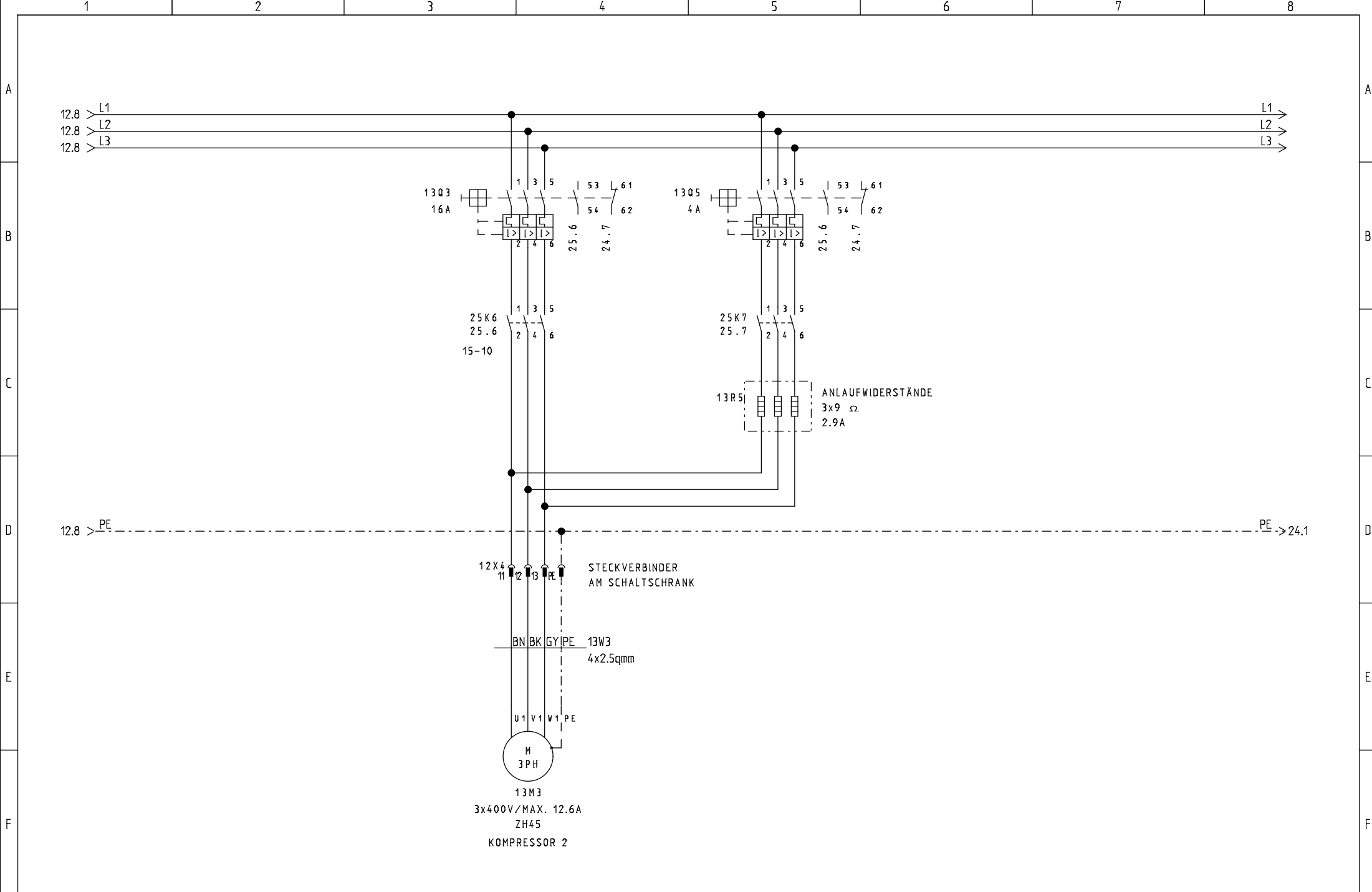

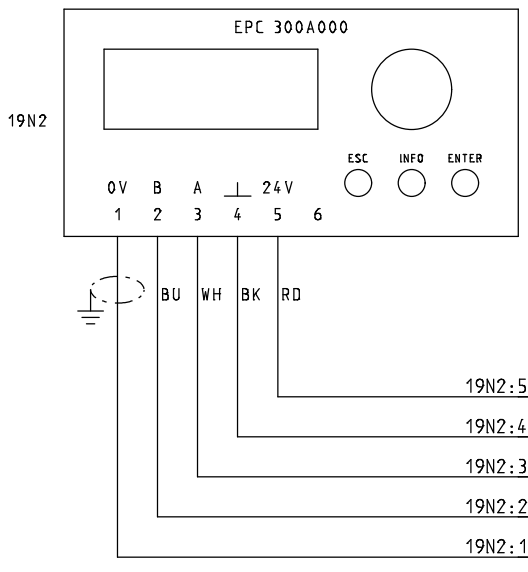

- 1 = SCHIRM
- 2 = BLAU
- 3 = WEISS
- 4 = SCHWARZ
- 5 = ROT

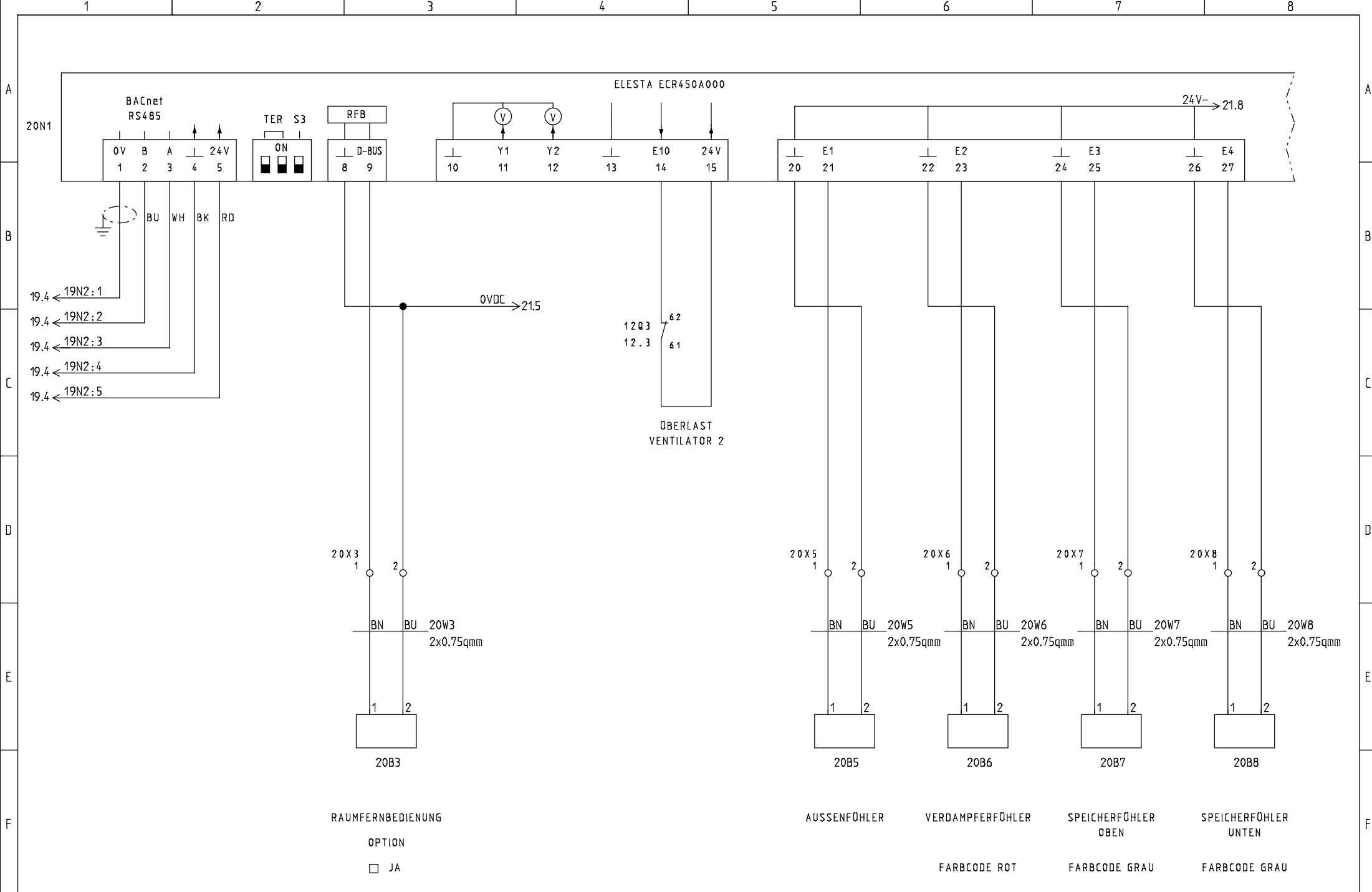

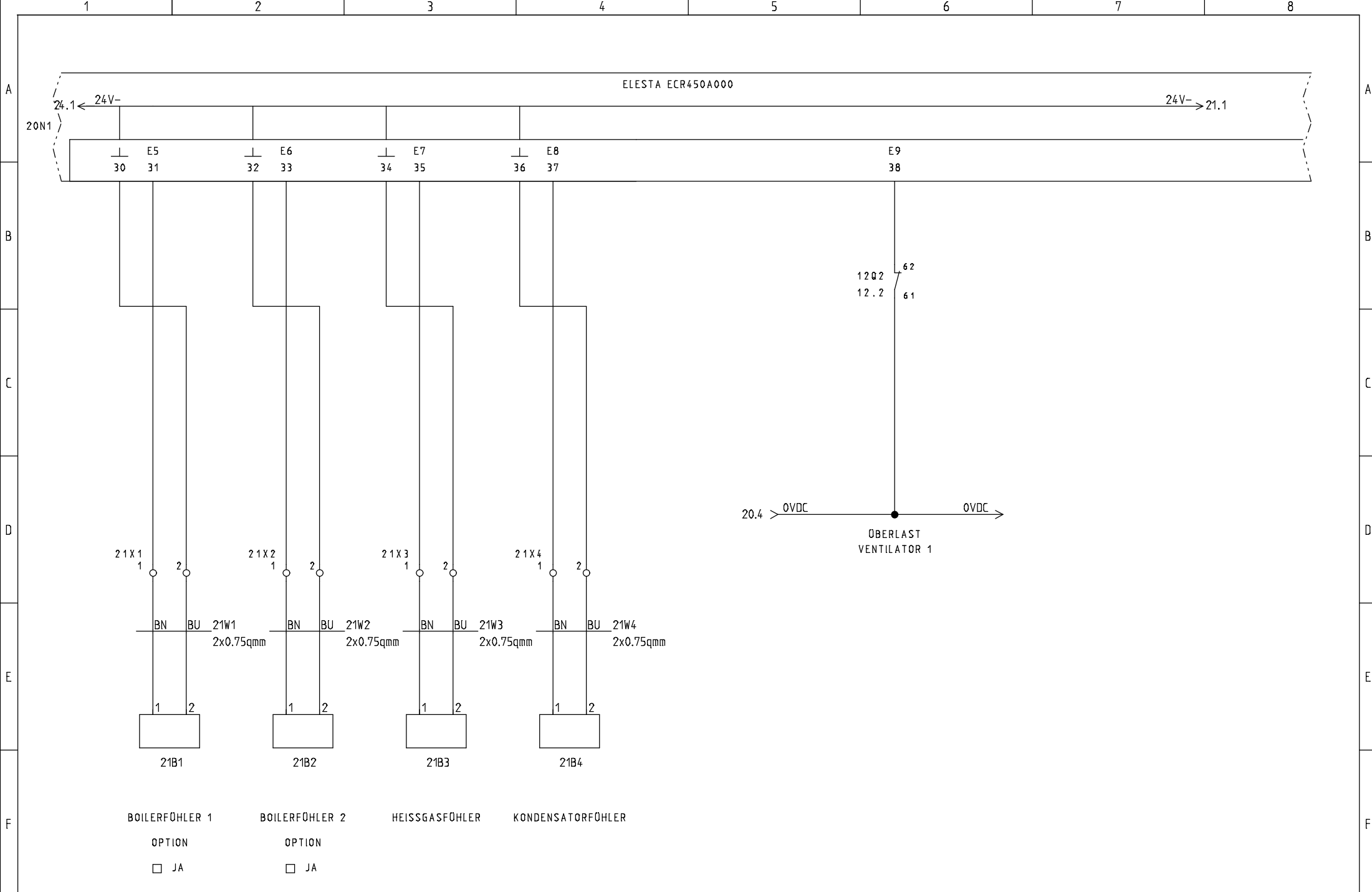

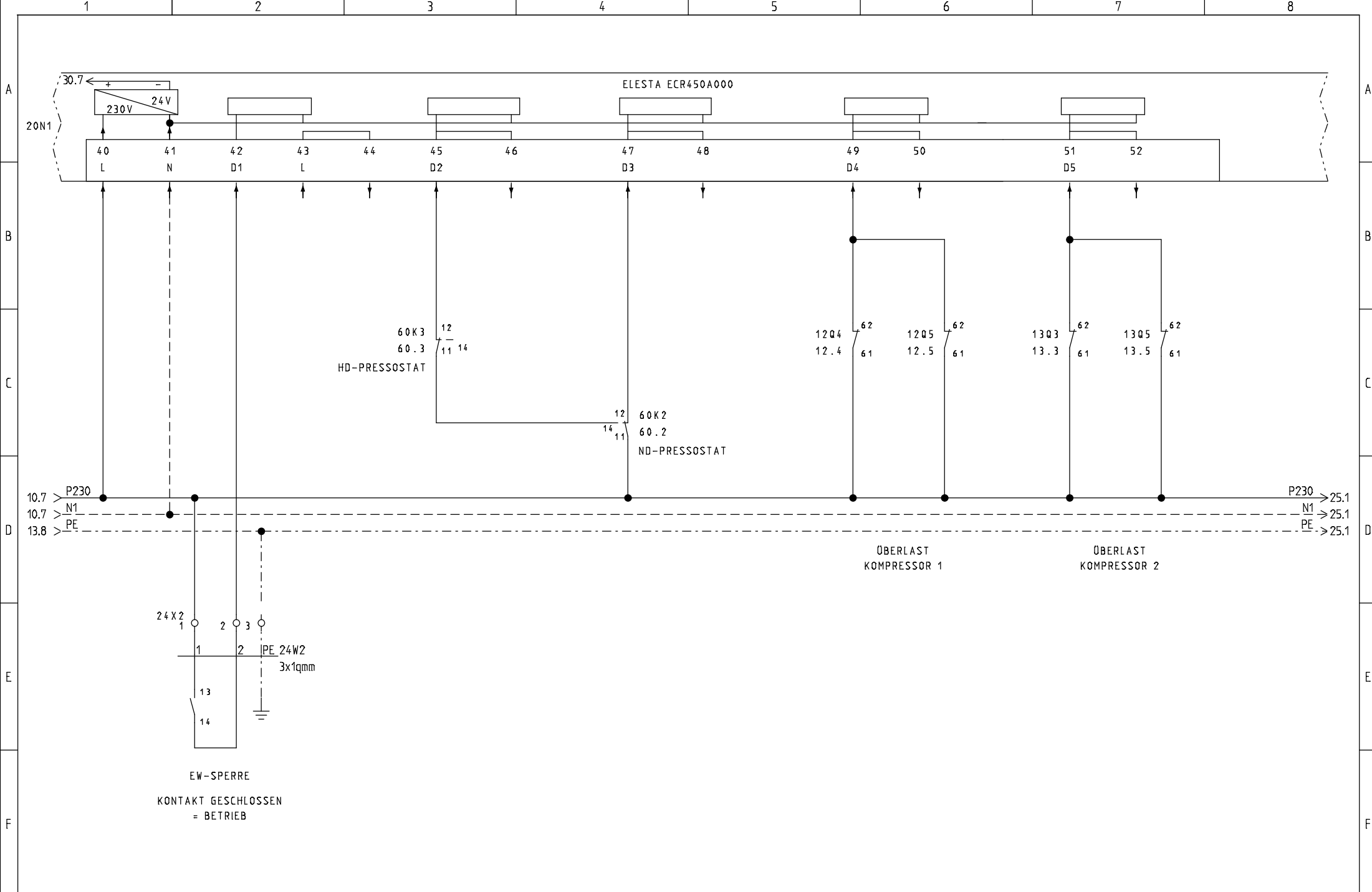

10.7 > P230  
 10.7 > N1  
 13.8 > PE

P230 > 25.1  
 N1 > 25.1  
 PE > 25.1

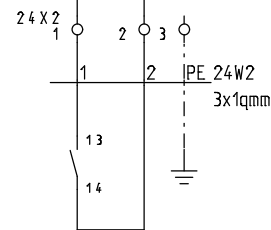

EW-SPERRE  
 KONTAKT GESCHLOSSEN  
 = BETRIEB

30.7

ELESTA ECR450A000

60K3  
 60.3  
 HD-PRESSOSTAT

12 60K2  
 14 60.2  
 11 ND-PRESSOSTAT

12Q4  
 12.4  
 62  
 61

12Q5  
 12.5  
 62  
 61

13Q3  
 13.3  
 62  
 61

13Q5  
 13.5  
 62  
 61

ÜBERLAST KOMPRESSOR 1

ÜBERLAST KOMPRESSOR 2



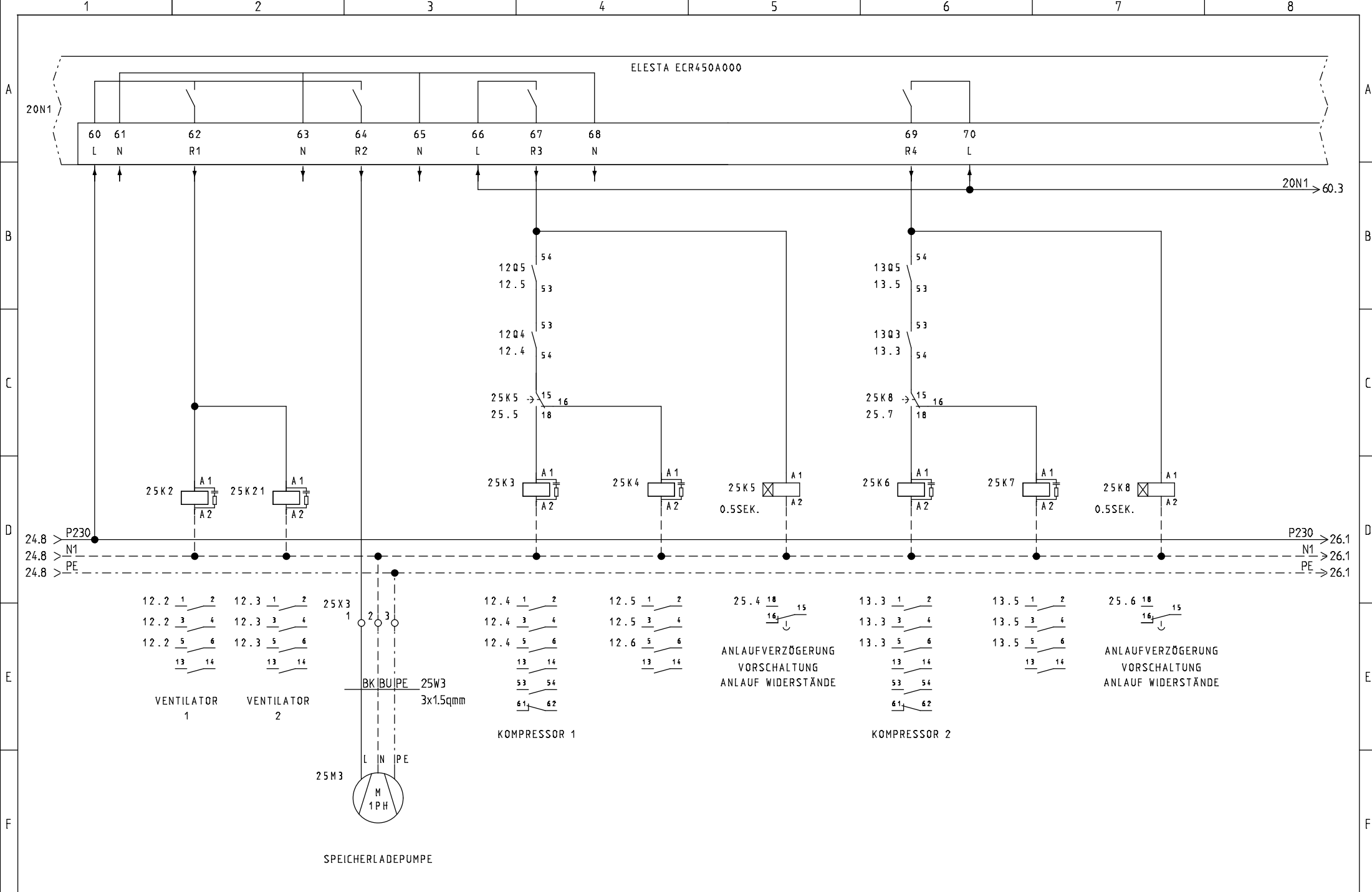

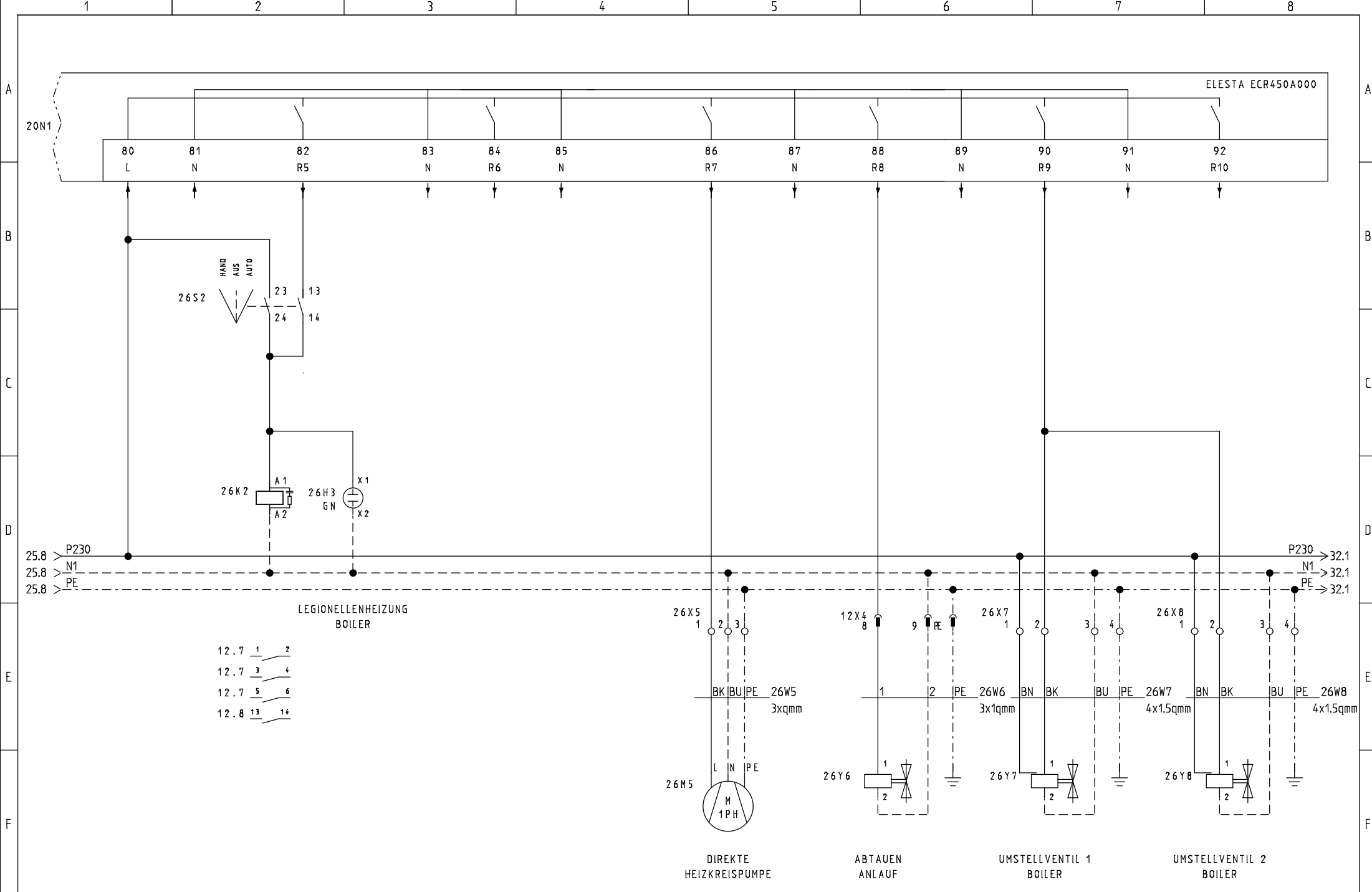

25.8 > P230  
 25.8 > N1  
 25.8 > PE

P230 > 32.1  
 N1 > 32.1  
 PE > 32.1

LEGIONELLENHEIZUNG  
 BOILER

12.7 1 2  
 12.7 3 4  
 12.7 5 6  
 12.8 13 14

26X5 1 2 3  
 BK BU PE 26W5 3xqmm

12X4 8 9 PE  
 1 2 PE 26W6 3x1qmm

26X7 1 2 3 4  
 BN BK BU PE 26W7 4x1.5qmm

26X8 1 2 3 4  
 BN BK BU PE 26W8 4x1.5qmm

26M5 L N PE  
 M 1PH

26Y6 1 2

26Y7 1 2

26Y8 1 2

DIREKTE HEIZKREISPUMPE

ABTAUEN ANLAUF

UMSTELLVENTIL 1 BOILER

UMSTELLVENTIL 2 BOILER



STRIEGA-THERM AG  
 STEUERUNG ZU WÄRMEPUMPE  
 LEGIONELLENHEIZUNG AWST36 1LT6.1

230VAC PUMPEN + VENTILE

Projekt: AWST36_1LT8.1	Zeichnungsnummer:	Rev.:	erstellt von:
Datum: 06.05.2020	Anlage:	Ort:	Blatt: 26

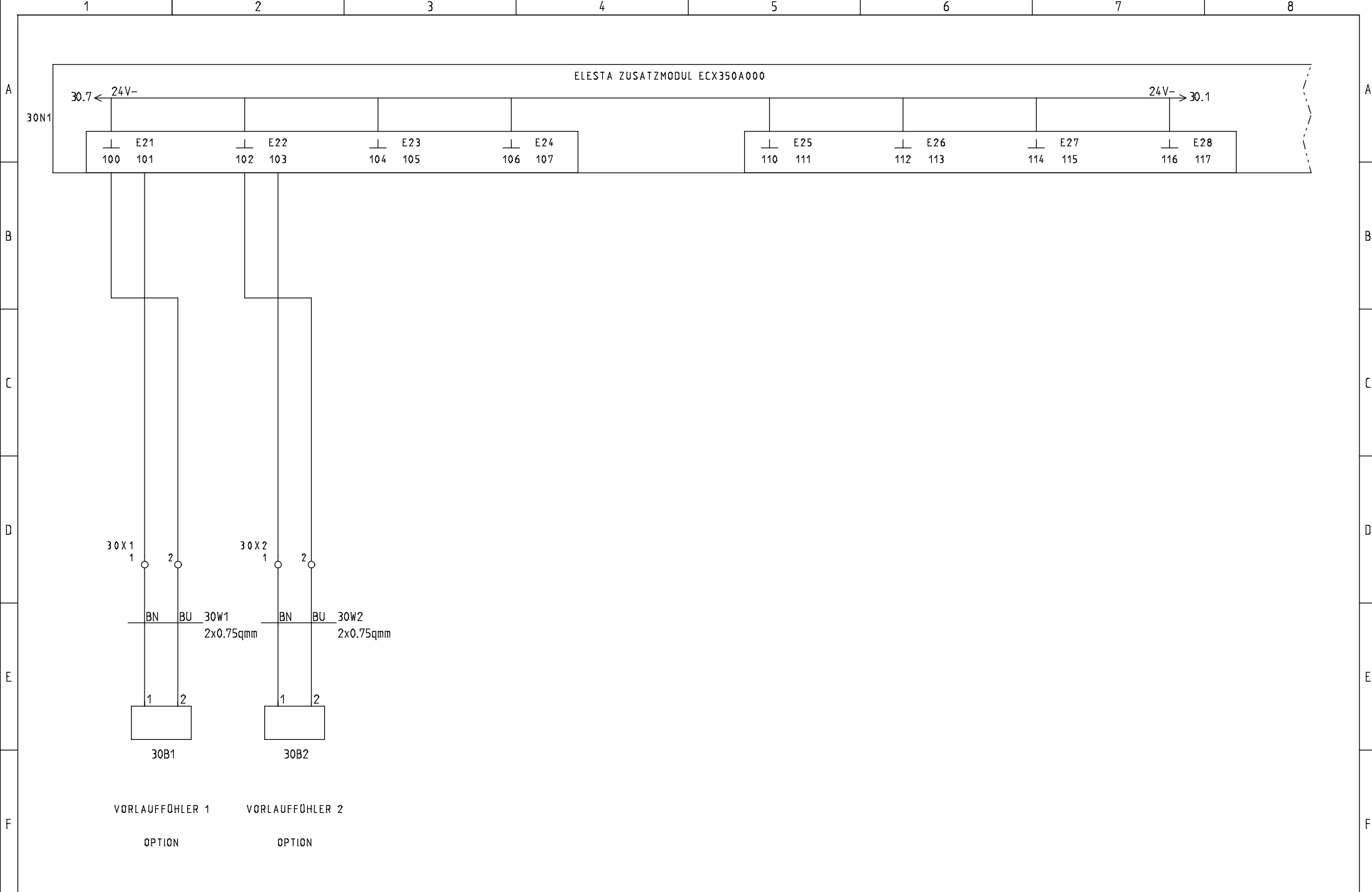

1 2 3 4 5 6 7 8

A

A

30N1

ELESTA ZUSATZMODUL ECX350A000

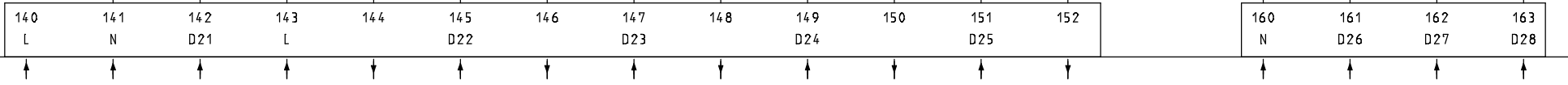

B

B

C

C

D

D

E

E

F

F



STRIEGA-THERM AG  
 STEUERUNG ZU WÄRMEPUMPE  
 LEGIONELLENHEIZUNG AWST36 1LT6.1

230VAC PUMPEN + VENTILE

Projekt:  
 AWST36\_1LT8.1

Datum:  
 06.05.2020

Zeichnungsnummer:

Anlage:

Rev.:

Ort:

erstellt von:

Blatt:  
 31

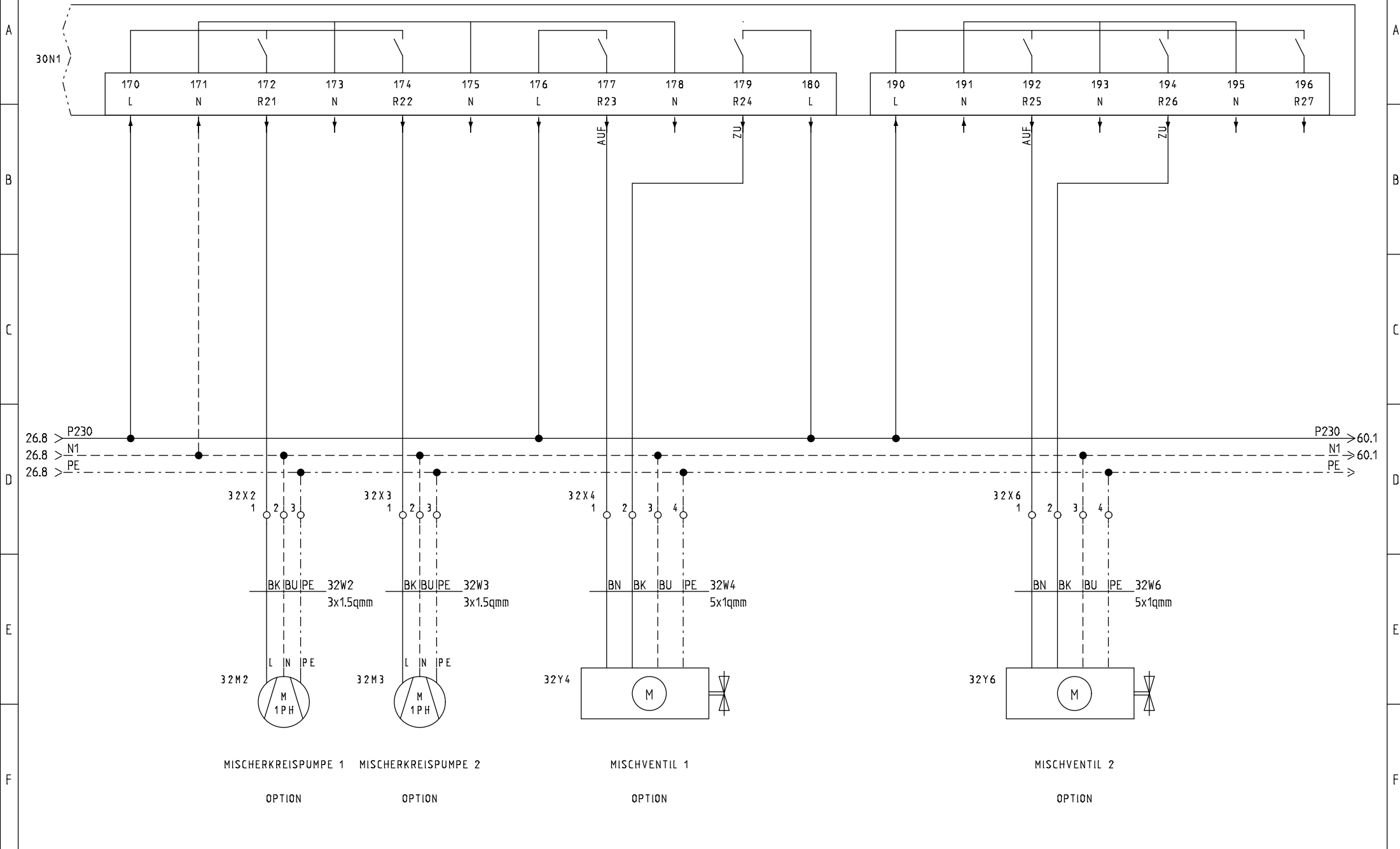

26.8 > P230  
26.8 > N1  
26.8 > PE

P230 > 60.1  
N1 > 60.1  
PE >

